

TACTICAL FLASHLIGHT

U n l e a s h T h e G l o w



NEW GEN

TACTICAL FLASHLIGHT

U n l e a s h T h e G l o w

OWNER'S MANUAL

For Model: LT-TL099PR2
LT-TL101
LT-ZL168
LT-ZL337
LT-EL228
LT-EL268
LT-EL338



CAUTION!

If you need to mount the flashlight onto a firearm, make sure firearm is not loaded before installation. Remove magazine and examine chamber. Use safe handling procedures at all times.

SwatForce flashlights produce substantial heat during operation. Do not leave activated flashlight unattended. Do not set activated flashlight face down. Do not place activated flashlight against combustible material or material that could be damaged by heat. Do not hold bezel or lens of activated flashlight against any portion of human body. Keep away from children.

Ensure that the flashlight cannot be turned on when stored or being transported. If the lamp is activated while in a case or any container, the lamp could overheat and cause damage to surrounding materials.

Do not touch a hot lamp assembly. Allow it to cool before handling. Avoid touching reflector surface. Always wear safety glasses when handling.

Examine battery quality and appearance before use each time and make sure that there is no leaking or any deformation. Dispose appropriately if there is a problem.

The batteries are pre-charged by the manufacturer, and cannot be recharged. Recharging can cause battery leakage or, in some cases, high-pressure rupture. Inadvertent charging can occur if a battery is installed backwards.

Install batteries by aligning the + and – signs marked on the battery with the + and – signs marked on the battery chamber in the light.

Turn off the light when not in use to conserve battery power.

Make sure to turn off the light or disconnect the pressure switch before inspecting bulb and battery if the light cannot be turned on.

Keep batteries cool and dry. Always remove batteries from light after use. Leaving battery in the light without use for long period of time may cause damage or danger.

Never use non-rechargeable and rechargeable batteries together in a light. Always replace batteries with the exact type and size specified for the light.

Always replace the whole set of batteries at the same time. Never mix new and used batteries in the same light.

Never deliberately short circuit batteries. Prolonged short circuit will cause the battery to lose energy and result in significant temperature increase.

Do not carry light with batteries installed in the car trunk while driving.

Keep battery compartment clean and keep any metallic object away from the battery.

Lithium batteries can explode or cause burns if disassembled, shorted, recharged, exposed to water, fire, or high temperatures. Do not place loose batteries in a pocket, purse, or other container containing metal objects. Do not mix new with used batteries or mix required batteries with other types of battery. Do not store batteries with hazardous or combustible materials. Store in cool, dry, ventilated area. Follow applicable laws and regulations for disposal.

Component Illustration

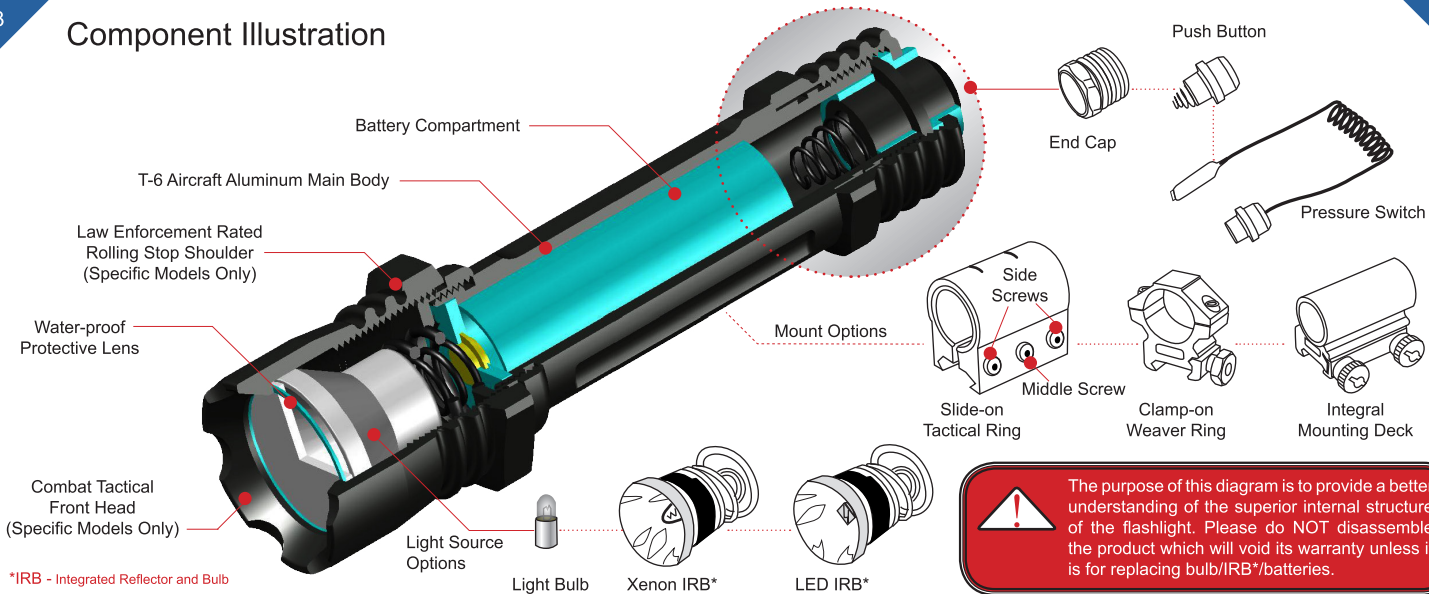

 The purpose of this diagram is to provide a better understanding of the superior internal structure of the flashlight. Please do NOT disassemble the product which will void its warranty unless it is for replacing bulb/IRB*/batteries.

FLASHLIGHT DATA TABLE

	Item Number	Specs							Accessory			Focus
		Bulb Type	Voltage	Max. Lumen	Battery Operating Time	Weight with Battery	Main Body Diameter	Length	Battery/ Qty	Pressure Switch	Mount/Ring	
Xenon Flashlight	LT-TL099PR2	Xenon Bulb	6V	95	70 mins	162g (5.7oz)	25.4mm (1")	138.6mm (5.45")	CR123A x 2	Included	Slide-on Tactical Ring	Adjustable
	LT-TL101	Xenon Bulb	6V	95	70 mins	234g (8.3oz)	22.5mm (0.89")	122mm (4.80")	CR123A x 2	Included	Integral Mounting Deck	Adjustable
	LT-ZL168	26.5 mm Xenon IRB*	6V	126	70 mins	160g (5.6oz)	25.4mm (1")	132.7mm (5.22")	CR123A x 2	Included	Slide-on Tactical Ring	Preset
	LT-ZL337	37 mm Xenon IRB*	9V	260	70 mins	255g (9oz)	27mm (1.07")	177.8mm (7.00")	CR123A x 3	Included	Integral Mounting Deck	Preset
LED Flashlight	LT-EL228	26.5 mm LED IRB*	6V	150	120 mins	185g (6.5oz)	27mm (1.07")	133.5mm (5.26)	CR123A X 2	Included	Integral Mounting Deck	Preset
	LT-EL268	26.5 mm LED IRB*	6V	150	120 mins	166g (5.9oz)	25.4mm (1")	139.6mm (5.50")	CR123A x 2	Included	Slide-on Tactical Ring	Preset
	LT-EL338	37 mm LED IRB*	9V	200	90mins	277g (9.8oz)	27mm (1.07")	181.1mm (7.13")	CR123A x 3	Included	Integral Mounting Deck	Preset

*IRB - Integrated Reflector and Bulb

PRODUCT IMAGE



LT-ZL337



LT-EL338



LT-TL099PR2



LT-TL101



LT-ZL168



LT-EL228



LT-EL268

Installation & Operation

Battery Installation

1. Unscrew the End Cap, install CR123A lithium batteries, following directions in (Fig1).
2. Screw the End Cap back to the original position.

Three Operation Modes

1. End Cap with Push Button Twist-on
 - 1). Tighten the End Cap until the light is on (Fig2-1).
2. End Cap with Push Button Momentary Push-On
 - 1). Tighten the End Cap until the light is on.
 - 2). Slightly loosen the End Cap until the light is off (Fig2-2).
 - 3). Press and hold the Push Button in the center to turn on the light. Release the Push Button to turn off the light. (Fig2-3)
 - 4). Repeat step 2.2) and 3.3) to find the best press/hold/release tension.
3. Pressure Switch Operation
 - 1). Separate the Push Button and the End Cap from the Main Body (Fig2-4).
 - 2). Replace the Push Button with the Pressure Switch (Fig2-5).
 - 3). Tighten the End Cap and Pressure Switch assembly snugly (Fig2-6).
 - 4). Press and hold the Pressure Pad in the middle to turn on the light. Release the Pressure Pad to turn off the light (Fig2-7).



Focus Adjustment

(For Focus Adjustable Models only, LT-TL099PR2, LT-TL101)

To adjust focus, turn the light on and rotate the Focus Ring either clockwise or counter-clockwise to get the desired result (Fig3).

Mounting the Flashlight

1. Slide-on Tactical Ring (For LT-TL099PR2, LT-ZL168, LT-EL268)
 - 1). Remove the End Cap from the flashlight (Fig4-1). (This step is not necessary for LT-TL099PR2)
 - 2). Slide the ring onto the flashlight. Rreplace the End Cap if it is previously removed.
 - 3). Slide the ring to the mount rail of the rifle or other application. Tighten the Side Screws on the ring to ensure a firm grip on the rail (Fig4-2).
 - 4). Tighten the Middle Screw to firmly secure the flashlight.
2. Integral Mounting Deck (For LT-TL101, LT-EL228, LT-ZL337, LT-EL338)
 - 1). Unscrew the 2 thumb nuts to loosen the locking plate.
 - 2). Fit the mounting deck to the mount rail of the rifle or other application.
 - 3). Tighten the 2 thumb nuts to ensure a firm grip on the rail (Fig4-3).



LT-ZL337/EL228/EL338 Mounting System Illustration

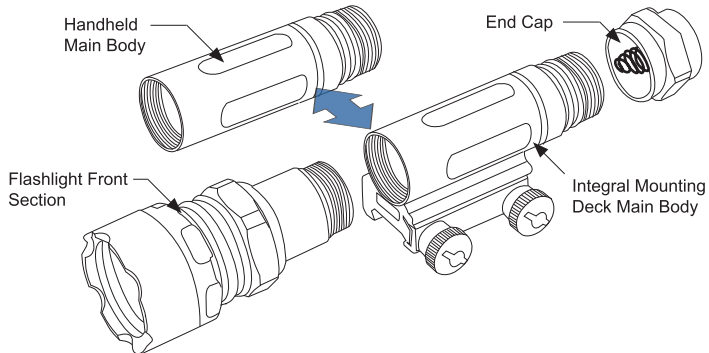

LT-ZL337/EL228/EL338 can be used as a handheld flashlight or a weapon-mount flashlight. To exchange:

1. Unscrew the flashlight End Cap and set it aside.
2. Remove the batteries from the battery compartment.
3. Separate the main body (either Handheld Main Body or Integral Mounting Deck Main Body) from the Front Section. Replace with the other style Main Body.
4. Replace the batteries and End Cap.

Bulb or IRB* Replacement

BULB REPLACEMENT

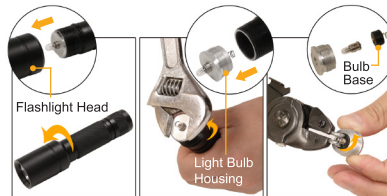

1. Make sure there is no battery in the light. Unscrew the Flashlight Head to expose the bulb.
2. Use a wrench to turn the Light Bulb Housing counter-clockwise to remove it from the flashlight. Be careful to securely grab the Light Bulb Housing with the wrench in this process.
3. Turn over the Light Bulb Housing. Use a snap ring plier to rotate the Bulb Base counter-clockwise as shown in the picture. Then, the bulb can be removed from the Light Bulb Housing.
4. Follow the above steps in reverse order to install a new bulb.

IRB* REPLACEMENT









1. Make sure there is no battery in the light. Unscrew the Front Head counterclockwise to expose the bulb.
2. Pull out IRB* from the Flashlight Head.
3. Follow the above steps in reverse order to install a new IRB*.

*IRB - Integrated Reflector and Bulb



Make sure the flashlight is totally cool down before replacing right bulb.

Replacement Parts Contact your flashlight distributor for the following replacement parts:			
	BLB-TL099	IRB-ZL026	IRB-EL026
	Light Bulb for LT-TL099PR2, LT-TL101	26mm Xenon IRB* for LT-ZL168	26mm LED IRB* for LT-EL228, LT-EL268
			
IRB-ZL037	IRB-EL037	TL-PSTL099-A	BAT-LIT870
37mm Xenon IRB* for LT-ZL337	37mm LED IRB* for LT-EL338	Deluxe Pressure Switch	2PC Set of CR123A Lithium Batteries

*IRB - Integrated Reflector and Bulb

Maintenance

1. Maintain the metal surface of the flashlight by removing any dirt or sand with a soft brush to avoid scratching the finish.
2. Store the flashlight in a cool dry place when not in use. Be careful to avoid contact with acid, alkaline or corrosive chemicals.
3. Replace the batteries in your flashlight every few months if it was not used for long period of time. This insures good working batteries for your light and prevents battery leakage.
4. Keep a fresh package of batteries next to your flashlight. This gives you back-up power for your light.
5. Do not store your flashlight in high temperatures. This would damage your flashlight and may result in battery leakage.
6. Do not put the flashlight head against any surface especially paper or human skin for it has heat and may result in accidents.
7. Do not leave your flashlight under the seat in your car, or in direct sunlight to avoid over-heating.
8. Do not attempt to lubricate any part of the flashlight.
9. Do not disassemble the flashlight other than replacing light bulb or pressure switch. Do not loosen or remove screws or parts. Any such or similar actions will void the warranty.

The Best Never Rest Warranty - Lifetime

Leapers, Inc. warrants that all UTG & UTG PRO products conform to published specifications and are free from defects in material and workmanship. We will repair or replace defective products for the duration of the product's life span. Our dedicated and professional in-house customer service team will go above and beyond to make things right and provide the best in-class customer service experience you expect to receive.

Our warranty does not extend to products damaged from misuse, accidental damage, negligence, natural disasters/accidents, or unauthorized repair or alteration.

For warranty service, please submit your inquiry by visiting our customer service page on our website at www.leapers.com or give us a call at 734-542-1500. A Return Authorization Number (RMA) must be assigned before returning any products for warranty service.

Disclaimer and Limitation of Liability

Leapers is pleased to offer suggestions of the use of its products, however Leapers neither assumes responsibility for any omissions or errors nor assumes liability for any damages that result from the use of its products in accordance with information provided by Leapers, whether verbal or written.

EXCEPT FOR THE EXPRESS WRITTEN WARRANTY SPECIFICALLY SET FORTH ABOVE, ALL EXPRESS AND IMPLIED REPRESENTATIONS AND WARRANTIES ARE HEREBY DISCLAIMED, INCLUDING ANY IMPLIED WARRANTY OF MERCHANTABILITY, NON-INTERFERENCE, FITNESS FOR A PARTICULAR PURPOSE, NON-INFRINGEMENT, OR WARRANTY OF ACCURACY OF ANY INFORMATION PROVIDED WHETHER WRITTEN OR ORAL. ALL WARRANTIES ARISING FROM ANY COURSE OF DEALING, LAW, USAGE OR TRADE PRACTICE ARE HEREBY EXPRESSLY EXCLUDED TO THE EXTENT ALLOWED BY LAW. TO THE EXTENT AN IMPLIED WARRANTY CANNOT BE EXCLUDED, SUCH WARRANTY IS LIMITED IN DURATION TO ONE YEAR. SOME STATES OR JURISDICTIONS DO NOT ALLOW LIMITATIONS ON HOW LONG AN IMPLIED WARRANTY LASTS, SO THE ABOVE LIMITATION MAY NOT APPLY TO YOU.

UNDER NO CIRCUMSTANCES IS LEAPERS, OR ITS SUPPLIERS OR RESELLERS LIABLE FOR ANY OF THE FOLLOWING EVEN IF INFORMED OF THEIR POSSIBILITY: 1) THIRD PARTY CLAIMS AGAINST YOU FOR DAMAGES; 2) SPECIAL, INCIDENTAL, OR INDIRECT DAMAGES OR FOR ANY ECONOMIC CONSEQUENTIAL DAMAGES; OR 3) LOST PROFITS, BUSINESS REVENUE, GOODWILL, OR ANTICIPATED SAVINGS. SOME STATES OR JURISDICTIONS DO NOT ALLOW THE EXCLUSION OR LIMITATION OF INCIDENTAL OR CONSEQUENTIAL DAMAGES, SO THE ABOVE LIMITATION OR EXCLUSION MAY NOT APPLY TO YOU.